

MAJA SURFACE

IP65



Power
3,6 w

Efficiency
56 Lm/w

Lifetime
50.000 Hours
(70% Lumen maintenance)

Input
10-30 VDC

Material
Stainless steel
Aluminum



MAJA SURFACE BIG (SS)
Stainless steel



MAJA SURFACE SMALL (SS)
Stainless steel

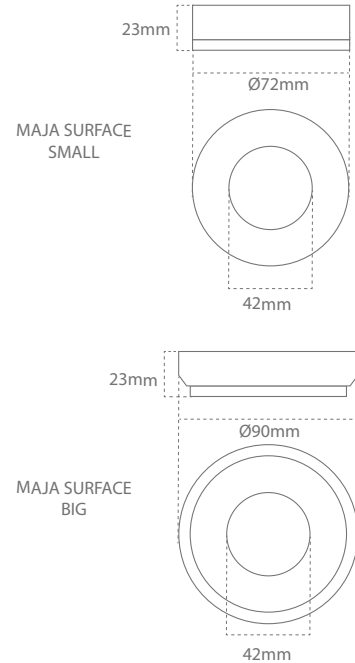

Product code	Lumen output	Beam	Power	CCT	CRI
MAJA-SURFACE-BIG-SS-WW	204 lm	90°	3,6W	3000K	> 80
MAJA-SURFACE-BIG-SS-WW-RED	204 lm	90°	3,6W / 1,8W RED	3000K / RED	> 80
MAJA-SURFACE-SMALL-SS-WW	204 lm	90°	3,6W	3000K	> 80
MAJA-SURFACE-SMALL-SS-WW/RED	204 lm	90°	3,6W / 1,8W RED	3000K / RED	> 80

Feature

- IP65 design with integral thermal management for long life
- High precision machining ensures perfect mechanical fit for long life
- Stainless steel ensures corrosion free product in damp environment
- PWM-dimmable
- Optional in Warm White 3000K with RED light

Material

- SS: Stainless steel
- Aluminium

Benefit

- High reliability
- Maintenance free

Application

- Marine light